



INSTRUCTIONS D'ASSEMBLAGE
ASSEMBLY INSTRUCTIONS

MONARCH
SPECIALTIES INC.

I 7056

CREDESCENCE -
TAUPE FONCE / 2 TIROIRS SUR ROULETTE

OFFICE CABINET -
DARK TAUPE WITH 2 DRAWERS ON CASTORS



**POUR DE L'ASSISTANCE OU POUR COMMANDER
DES PIÈCES CONTACTEZ NOTRE DÉPARTEMENT
DE SERVICE À LA CLIENTÈLE.**

**FOR ASSISTANCE OR TO ORDER PARTS
CONTACT OUR CUSTOMER SERVICE DEPARTMENT**

WWW.MONARCHSERVICE.COM

LISTE DES PIÈCES
PARTS LIST

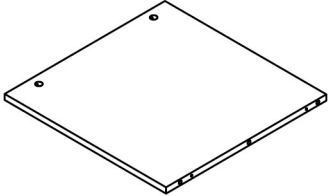
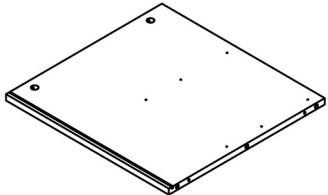
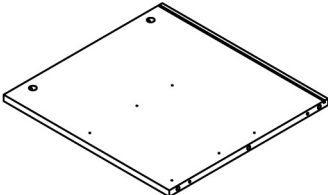
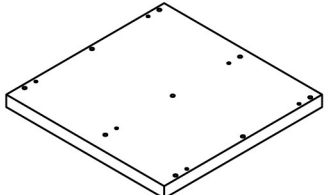
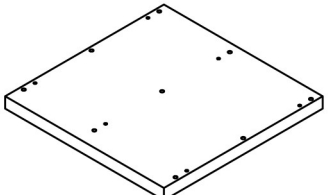
PIÈCE / PART #	IMAGE	DESCRIPTION	QTY / QTÉ
1		FRONT FACING LEFT SIDE PANEL PANNEAU DE CÔTÉ GAUCHE	1
2		FRONT FACING RIGHT SIDE PANEL PANNEAU DE CÔTÉ AVANT DROIT	1
3		DIVIDER PANEL PANNEAU DE DIVISION	1
4		BOTTOM PANEL PANNEAU DU BAS	1
5		TOP PANEL PANNEAU DE SURFACE	1

LISTE DES PIÈCES
PARTS LIST

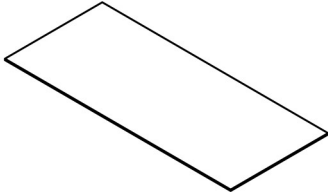
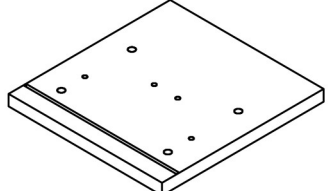
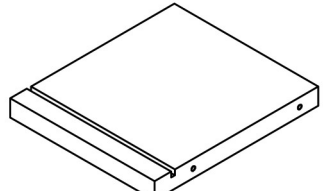
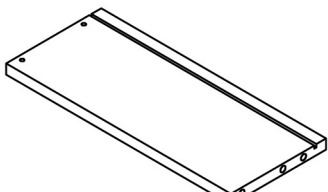
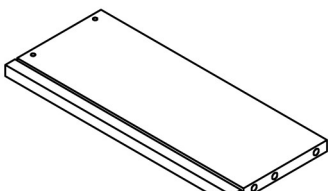
PIÈCE / PART #	IMAGE	DESCRIPTION	QTY / QTÉ
6		BACK PANEL PANNEAU ARRIÈRE	1
7		DRAWER FRONT PANEL PANNEAU AVANT TIROIR	2
8		DRAWER BACK PANEL PANNEAU ARRIÈRE TIROIR	2
9		DRAWER SIDE PANEL PANNEAU DE CÔTÉ TIROIR	2
10		DRAWER SIDE PANEL PANNEAU DE CÔTÉ TIROIR	2

LISTE DES PIÈCES
PARTS LIST

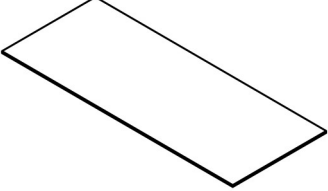
PIÈCE / PART #	IMAGE	DESCRIPTION	QTY / QTÉ
11		DRAWER BOTTOM PANEL PANNEAU DU BAS TIROIR	2

LISTE DES PIÈCES DE MONTAGE
HARDWARE LIST

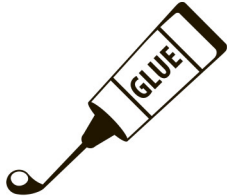
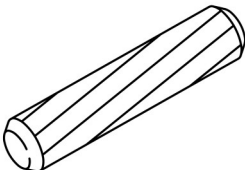
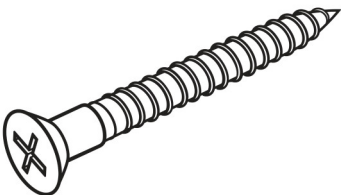
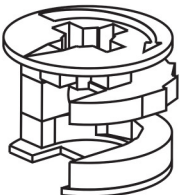
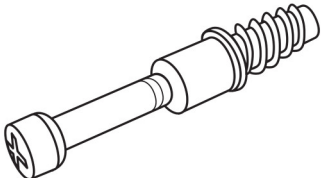
PIÈCE / PART #	IMAGE	DESCRIPTION	QTY / QTÉ
A		GLUE COLLE	1
B		WOOD DOWEL - Ø3/8" X 1 1/8" GOUJON DE BOIS - Ø3/8" X 1 1/8"	26
C		ASSEMBLING SCREW - 1 5/8" VIS D'ASSEMBLAGE - 1 5/8"	6
D		CAM LOCK CONNECTOR - Ø5/8" X 1/2" ÉCROU CAM LOCK - Ø5/8" X 1/2"	10
E		CAM LOCK SCREW - 1 3/8" VIS CAM LOCK - 1 3/8"	10

LISTE DES PIÈCES DE MONTAGE
HARDWARE LIST

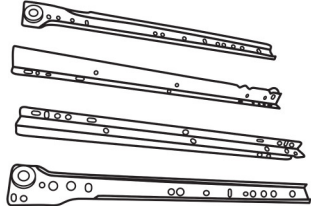
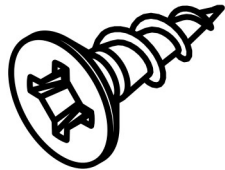
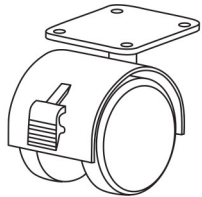
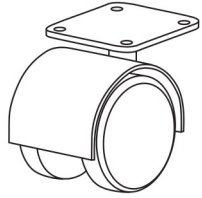
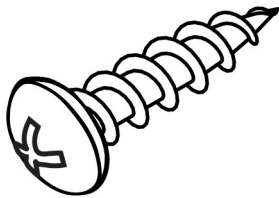
PIÈCE / PART #	IMAGE	DESCRIPTION	QTY / QTÉ
F		METAL DRAWER SLIDE - 13 3/4" COULISSE DE MÉTAL - 13 3/4"	2
G		ASSEMBLING SCREW - 1/2" VIS D'ASSEMBLAGE - 1/2"	24
H		WHEEL - Ø2" ROUE - Ø2"	2
I		WHEEL - Ø2" ROUE - Ø2"	2
J		ASSEMBLING SCREW - 5/8" VIS D'ASSEMBLAGE - 5/8"	16

LISTE DES PIÈCES DE MONTAGE
HARDWARE LIST

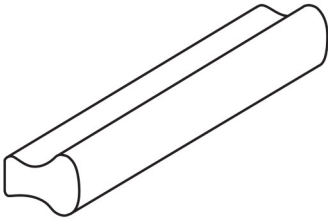
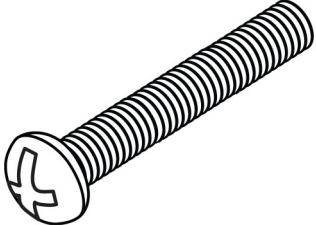
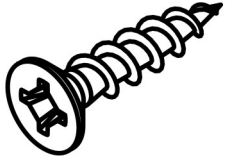
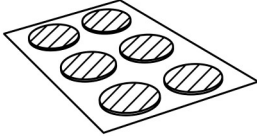
PIÈCE / PART #	IMAGE	DESCRIPTION	QTY / QTÉ
K		HANDLE - 2" POIGNÉE - 2"	2
L		ASSEMBLING BOLT - 7/8" BOULON D'ASSEMBLAGE - 7/8"	4
M		ASSEMBLING SCREW - 1 3/8" VIS D'ASSEMBLAGE - 1 3/8"	8
N		FINISHING STICKER - Ø3/4" COLLANT DE FINITION - Ø3/4"	10

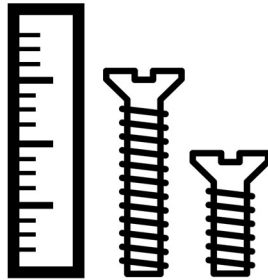

OUTIL DE VÉRIFICATION DE DIMENSIONS DES PIÈCES
HARDWARE DIMENSIONS VERIFICATION TOOL

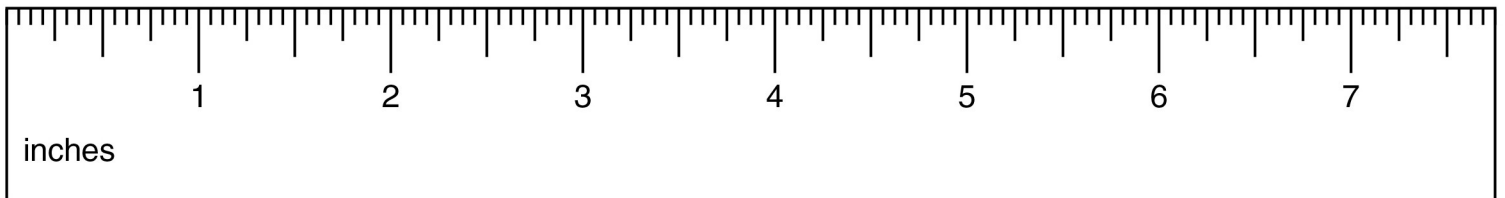

ÉTAPE / STEP 1

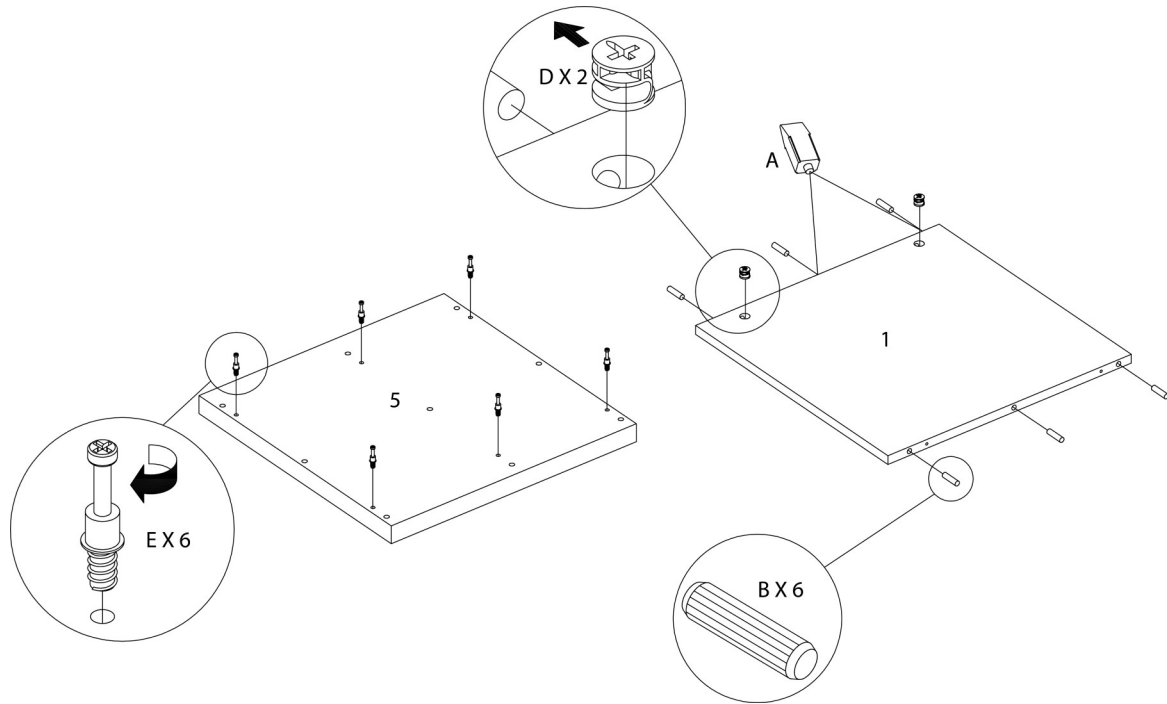

ÉTAPE / STEP 2

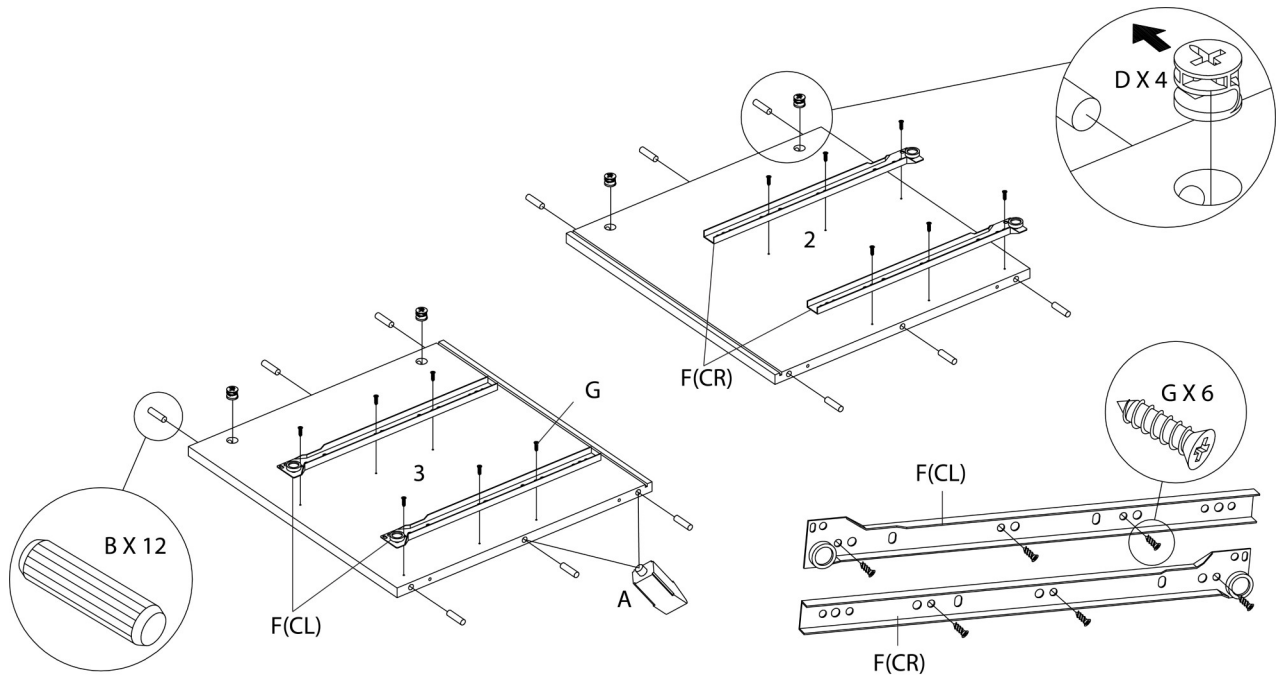

ÉTAPE / STEP 3

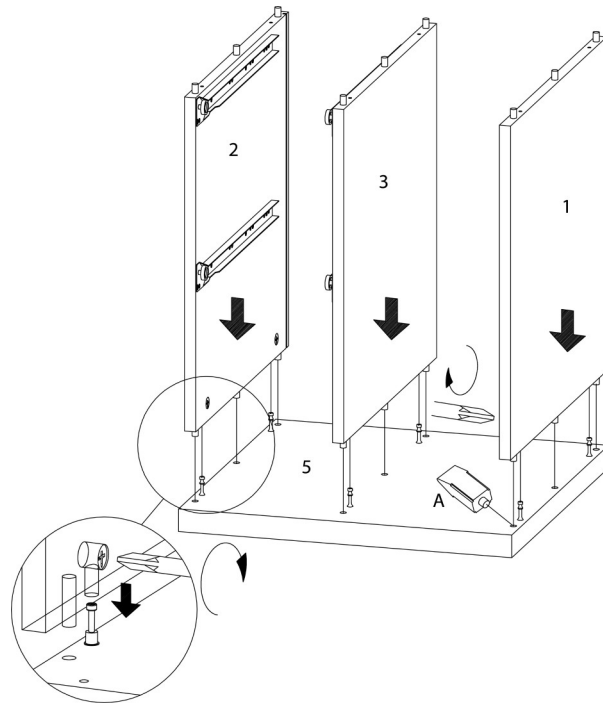

ÉTAPE / STEP 4

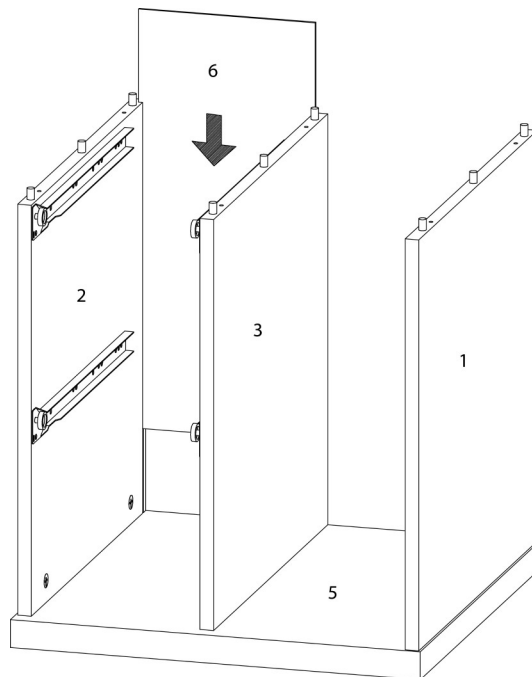

ÉTAPE / STEP 5

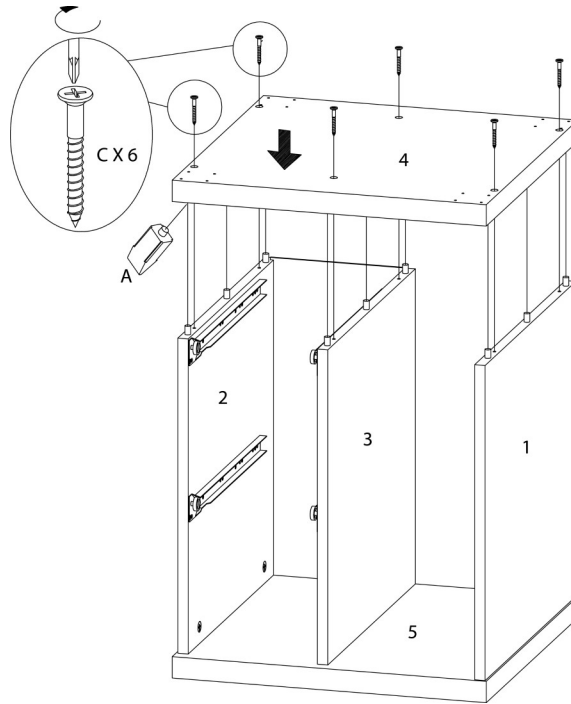

ÉTAPE / STEP 6

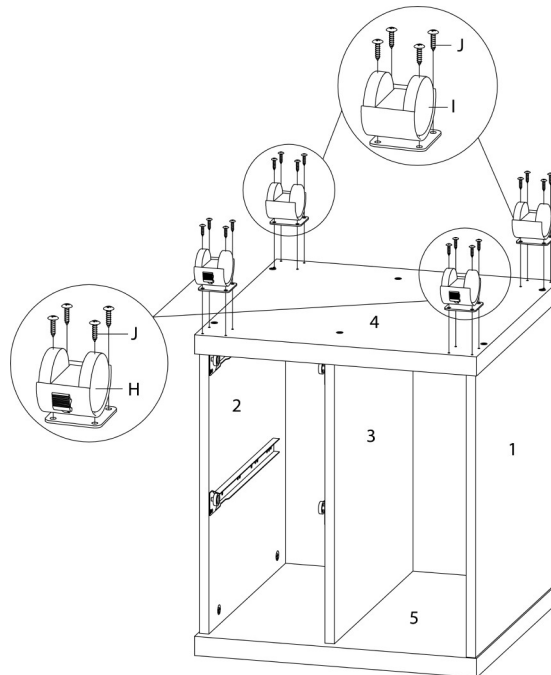

ÉTAPE / STEP 7

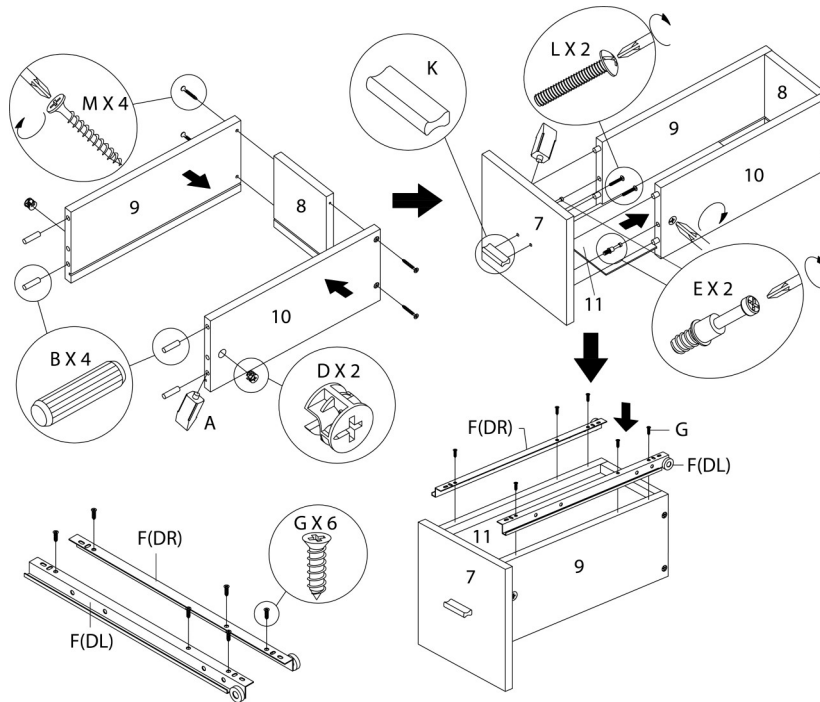

ÉTAPE / STEP 8

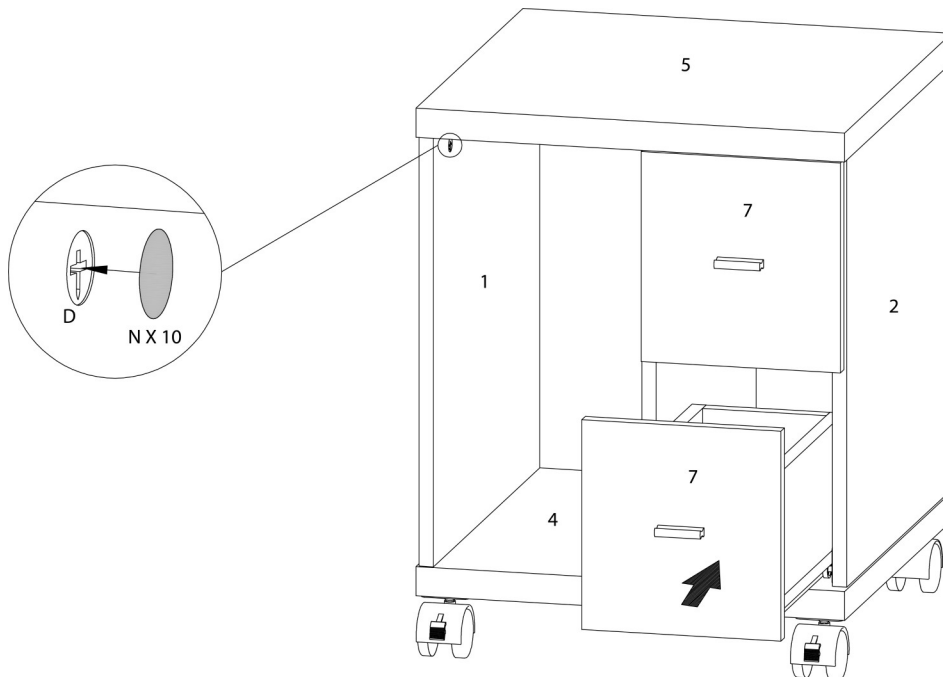

ÉTAPE / STEP 9

